



EIFS

application guide

This application guide only addresses the application, not design, and is intended for use by the applicator and not the designer.

This guide must be used in conjunction with the System specifications, Evaluation Report, product datasheets, system details, project details, and construction documents.

If the documents have contradictory information, contact FacadesXi before installing. FacadesXi is committed to quality products and quality systems. Please contact us if there are any questions or if we can help you with your installation.

A full inspection checklist can be found at: www.facadesxi.com

1. INTRODUCTION	2
2. FACADESXi PRODUCTS	3
3. SYSTEMS AND COMPONENTS	4
4. PRE-PROJECT INSTALLATION & VERIFICATION	5
5. SUBSTRATE	7
6. EIFS INSTALLATION	8

2.1 Xi-WaterShield Water & Air Barrier Assembly

- Xi-WaterShield: Liquid applied air/water barrier
- WaterShield Joint Mesh: Fiberglass Mesh bonded to a non-woven textile. When embedded in Xi-WaterShield it can span gaps and joints up to 1/4"
- WaterShield Flashing Membrane: Primer-Free peel and stick tape. The polyester fabric top layer provides an excellent bonding surface for WaterShield or Xi-Base Coats
- Xi-FlashFill: Gunnable or Trowelable waterproofing sealant applied at 12 mils

2.2 Insulation board adhesives

- Xi-Dry Acrylic Base Coat: Dry polymer containing portland cement mixed with water in the field
- Xi-Acrylic Base Coat: 100% acrylic base coat mixed with Portland cement in the field
- Xi-EZ Adhesive: Ready-to-use 100% acrylic adhesive

2.3 Xterior Insulation

- Expanded Polystyrene (EPS): Nominal 1.0 lb/ft³ (16 kg/m³) in compliance with ASTM C578 Type I /ASTM E2430
- Styrofoam™ Brand Panel Core 20 Expanded Polystyrene (XPS): Pre-rasped, Nominal 1.5 lb/ft³ (24 kg/m³) in compliance with ASTM C578 Type X

2.4 Base Coats

- Xi-Dry Acrylic Base Coat: Dry polymer containing Portland cement mixed with water in the field
- Xi-Acrylic Base Coat: 100% acrylic base coat mixed with Portland cement in the field
- Xi-EZ Base: Ready-to-use 100% acrylic adhesive and base coat

2.5 Reinforcing Mesh

- Xi-Mesh Standard Reinforcing Mesh: 4.2 oz/ yd² open weave glass fiber coated reinforcing mesh
- Xi-Mesh 6: 6 oz/ yd² open weave glass fiber coated reinforcing mesh for standard impact resistance
- Xi-Mesh 11: 11 oz/ yd² open weave glass fiber coated reinforcing mesh for intermediate impact resistance

- BearMat 15 / Xi-Mesh 4: 15 oz/ yd² open weave glass fiber coated reinforcing mesh for high impact resistance (must be used in conjunction with Xi-Mesh)
- BearMat 20 / Xi-Mesh 4: 20 oz/ yd² open weave glass fiber coated reinforcing mesh for ultra-high impact resistance (must be used in conjunction with Xi-Mesh)

2.6 Primer

- Xi-Alkali Resistant Primer: 100% Acrylic tintable primer

2.7 Finish Coats

- Xi-Textured Acrylic Finish Coat: 100% Acrylic polymer, dirt pick-up resistant textured finish coat with integral color and texture
- Xi-Flexx Elastomeric Finish: 100% Acrylic resin-based Elastomeric dirt pick-up resistant textured finish coat with integral color and texture
- Textures:

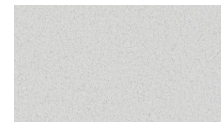

Xi-Smooth Extra

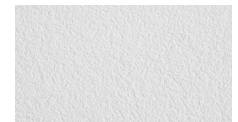

Xi-Smooth

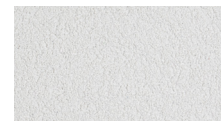

Xi- Ultra Fine Sand

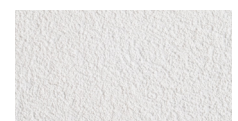

Xi-Fine Sand

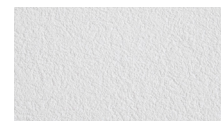

Xi-Medium Sand



Xi-Coarse Sand

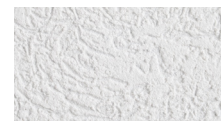

Xi-Fine Swirl



Xi-Coarse Swirl

Each System contains component options for certain layers.
See Project specifications for the project specifics.

	WATERSHIELD XTERIOR Insulation System	WATERSHEILD XPS Insulation System	XI-FASTENED Systems	XTERIOR Insulation System
Water Resistive Barrier	Xi-WaterShield and Accessory Products		Code Compliant Water Resistive Barrier	None
Means of Drainage	Vertical Ribbons of Adhesive		<ul style="list-style-type: none"> • Three Dimensional drainage mat • Code compliant sheet good with an internal means of drainage • Grooved Insulation Board 	None
Insulation Board Attachment	<ul style="list-style-type: none"> • Xi-Acrylic Base Coat • Xi-Dry Acrylic Base Coat • Xi-Adheisve 		WindLock Wind Devil 2 with appropriate screws	<ul style="list-style-type: none"> • Xi-Acrylic Base Coat • Xi-Dry Acrylic Base Coat
Xterior Continuous Insulation	Expanded Polystyrene	Styrofoam™ Panel Core 20 (no substitutions)	Expanded Polystyrene	Expanded Polystyrene
Base Coat	Xi-Acrylic Base Coat ♦ Xi-Dry Acrylic Base Coat ♦ Xi-EZ Base Coat			
Reinforcing Mesh	Xi-Mesh ♦ Xi-Mesh6 Xi-Mesh11 ♦ BearMat 15/Xi-Mesh ♦ BearMat 20/Xi-Mesh			
Primer (Optional per specification)	Xi-Alkali Resistant Primer			
Finish Coat	Xi-Textured Acrylic Finish ♦ Xi-Flexx Finish			

WATERSHIELD XTERIOR

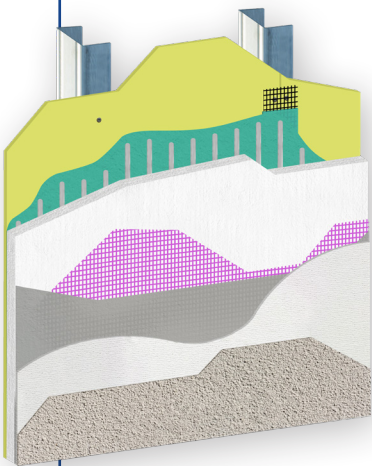

XTERIOR EIFS

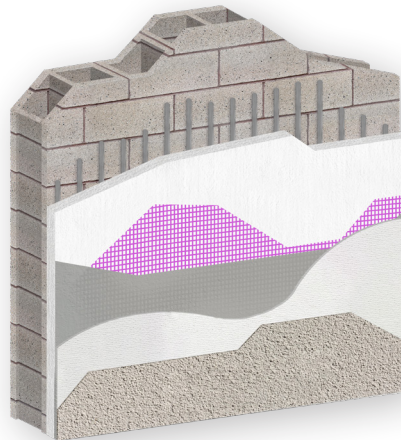

WATERSHIELD XPS



XI-FASTENED



4.1 Delivery/Storage/Handling

- Deliver FACADESXi materials in original unopened packages with labels intact.
- Protect FACADESXi materials during transportation and installation to avoid physical damage.
- Protect Portland cement-based material (bag products) from moisture and humidity. Store undercover and off the ground in a dry location.
- Store FACADESXi materials in a cool, dry place that is protected from freezing and out of direct sunlight.
- Store insulation boards in original packaging, flat and out of the heat and direct sunlight.

4.2 Pre-Project considerations

Although outside of the scope of EIFS installation the following items should be considered and brought to the attention of the general contractors and/or designer as applicable.

EIFS Wall Assembly

- Allowed on Vertical Walls only.
- Slope Minimums: Standing Snow areas – 6:12. No Standing Snow - 3:12.
- Horizontal/Sloped surfaces greater than 2 inches must be coated with Xi-WaterLock.
- Separate the EPS insulation board from the interior of the building by a minimum 15-minute thermal barrier.

Drainage/Flashing/Moisture/Air Protection

- The system must be designed and installed to allow moisture to drain to the exterior per the International Building Codes.
- Design flashing to direct water to the exterior, including above window and door heads, window and door sills, at roof/wall intersections, decks, floor lines, high to low wall intersections, at the base of the wall, and where required by code and in the project details.

- The use of vapor retarders on the interior side of the wall is typically only used in colder climates and is the decision of the designer.
- The project details must contain air barrier continuity transitions to other wall components, including all penetrations and wall connections when an air barrier is required. FXI, the adjoining material manufacturer and the architect must approve the air seal designs.

Finish Coat Color - It is generally recommended to select a finish color with a light reflectance value (LRV) of 20 percent or higher (usually lighter colors) due to the EPS service temperature limitation of approximately 160° F (71° C).

4.3 Project conditions

- Ambient and surface temperature must be above 40° F (4° C) during application and for 24 hours after application of FACADESXi materials.
- Provide supplementary heat/shading for installation, if necessary, to maintain minimum or maximum allowable temperatures.
- Prevent uneven or excessive evaporation of moisture from base coat during dry, hot weather. Do not install coatings in temperatures above 100° F (37° C).
- Protect surrounding areas and adjacent surfaces from the application of materials.

4.4 Coordination and Scheduling

- A preconstruction meeting is recommended and should include the Manufacturer, the applicator, the owner, the coordinating material representative, and [consultants] before the installation of the materials.
- Coordinate and schedule installation of FACADESXi with related work; windows, doors, flashing, AC units, foundation waterproofing, roofing, trim, flashing, and joint sealers, to prevent water infiltration to ensure the drainage of the system.



- Protect sheathing per industry and/or sheathing manufacturer's instructions.
- Install penetrations such as ducts and pipes, and seal at the water barrier layer to create a continuous water and air barrier.
- Install window/door and large penetration head flashing immediately after windows and doors are installed.
- Install parapet cap/copings and sealant immediately after base coat finish has dried.
- If installing flashing and/or sealants after the finish coat has been installed, the areas must be taped off and protected. Do not apply a sealant to the finish coat without approval.
- Attach small penetrations through the system per application details and provide a water-tight seal.

4.5 Expansion Joints/ Penetration Joints

The placement of the expansion joints is the responsibility of the Designer and should be shown on the project drawings. EIFS does not require control joints, nor should they be installed.

Minimum 3/4 inch joints (or as per the designer) are required at:

- Building expansion joints
- Wood floor lines where deflection is expected
- At dissimilar materials or dissimilar walls
- Changes in building height

Minimum 1/2 inch joints (or as per the designer) are required at penetrations through the EIFS such as windows, doors, electrical, or mechanical.

The System must be properly back-wrapped, prewrapped, or encased in approved vinyl trim accessories at all terminations.

5.1 Allowable Substrates

WaterShield Xterior Insulation Systems

- 1/2" minimum Exterior Glass Mat Gypsum Sheathing complying with ASTM C1177: DensGlass® sheathing, GlasRoc® sheathing Weather Defense® sheathing, and eXP® sheathing
- 1/2" minimum Exterior fiber reinforced cement sheathing complying with ASTM C1325
- 1/2" minimum APA Exposure 1 or exterior plywood (Grade C/D or better)
- 1/2" minimum APA Exposure I OSB
- Unpainted CMU, Concrete, Brick
- Other substrates, or painted as approved by FACADESXi

Xterior Insulation System

- CMU
- Concrete
- Brick

Xi-WaterShield, WaterShield Flashing Membrane, Xi-FlashFill

- WaterShield Xterior Insulation Sheathings
- Wood Framing
- Steel Framing and Flashing
- Aluminum
- PVC
- Stainless Steel
- Aluminum

Substrate Notes

- Concrete and Concrete Masonry must be cured for 28 days, and the alkalinity must be less than 10.
- Pressure-treated wood: Clean and test for adhesion.
- Raw gypsum board edges: When installing Xi-WaterShield/WaterShield Flashing Membrane and Xi-FlashFill on soffits or around corners, it is best to use the factory edge of gypsum products. WaterShield products (and most products) will not adhere to raw gypsum.
- Window fins, metal flashings, or other components: Test adhesion before application of any WaterShield product. If adhesion is weak, wipe with isopropyl alcohol, allow to dry and re-test.

5.2 Substrate Examination

Unsatisfactory conditions shall be corrected before the installation of any FACADESXi System materials. The contractor must notify the general contractor and/or owner and/or architect of all discrepancies. Do not proceed with the water/air barrier or adhesive until conditions are resolved.

Verify the following:

- The substrate is allowable and code compliant and installed per the manufacturer or appropriate product installation instructions.
- The substrate is flat, and free of irregularities greater than 1/4 inches in 4 feet.
- Surfaces are free of mildew, dirt, efflorescent, oils, damage deterioration, or any foreign materials.
- Surfaces are free from excessive moisture; moisture content should be recorded before the installation of the water barrier materials. Plywood and OSB moisture content must not exceed 19%.
- Painted/loose/damaged substrates have the paint removed by water/sandblasting and damage repaired so that 90% of the virgin substrate is exposed and adhesion tested before installation. Contact FACADESXi Technical Department when applying overpainted/damaged substrates.

5.3 Flashing Examination

- Although not a part of the Xterior Insulation Systems, flashings and sealants are elements of all exterior wall assemblies and must be designed, integrated, and installed, in conjunction with the wall cladding to create an air and water-resistant assembly and a means for drainage of incidental moisture from within the system.

If Flashings are considered a part of the EIFS installation:

- Install flashings per project details.
- All rough openings, penetrations, balconies, and decks must be flashed following the project details and, in a matter, to prevent water penetration.
- Head, jamb, and sills of all openings must be flashed and sealed in conjunction with the water/air barrier per project details to create positive drainage.
- Roof Flashing and Kick out Flashing must be installed per industry guidelines and project details.

Products not supplied by FacadesXi must be installed per manufacturers' installation instructions and the applicable building code.

6.1 Mixing

All Mixing instructions must follow the most up-to-date product datasheet.

6.2 Xi-WaterShield Assembly

See *WaterShield Application Handbook and WaterShield Assembly Details for full installation instructions.*

6.3 System Terminations

An exposed insulation board is never allowed. Terminate the insulation boards using an acceptable method below.

6.3.1 Termination of Insulation board at base of wall, large openings, top of wall

Backwrap—the reinforcing mesh is mechanically or adhesively secured to the substrate before the installation of the insulation board and continued onto the face of the insulation board. (See Fig. 1)

1. If applicable, apply Water Resistive Barrier / Xi-WaterShield
2. Attach detail mesh onto the substrate by applying a ribbon of Xi-Base on the substrate and embed the Xi-Mesh. Staples may be acceptable in some installations but adhesive is the preferred method of attachment.
3. The mesh will “hang” in place until the insulation board has adhered. Keep the mesh clean and free of base coat and dirt. The mesh will eventually be wrapped onto the face of the board and embedded with Basecoat. (See Base Coat /Reinforcing Mesh Section – Xi-Base not shown) Detail mesh must extend onto the face 2.5 inches.
4. The insulation boards will be installed over the Backwrap mesh.

Edgewrap—at the perimeter of the EIFS, the reinforced base coat is wrapped from the face of the insulation board onto the edge of the substrate. (Fig. 2a and 2b)

1. Water Resistive Barrier, and Exterior Insulation Boards are installed.
2. Xi-Mesh and Xi-Base are installed and are wrapped into the rough openings. This is typically at opening jambs where drainage is not required.

If drainage is required, edgewrap is not the correct termination method.

Pre-wrap—precoated “Starter board”. The reinforced base coat is installed approximately 4 inches on the back and bottom edge (Fig. 3a) (and optionally also the front) (Fig. 3b) of the insulation boards and allowed to dry before being adhered to the wall.

1. Leave 2-1/2 inches of reinforcing mesh hanging off the sides of one side of each starter board so that after installation, the reinforcing mesh can overlap with the adjacent mesh.
2. The Base and Mesh may be installed along the entire bottom and exterior face, but that makes rasping and lapping mesh more difficult. It is easier to leave the face clear until after the boards have been adhered to the wall.
3. When insulation boards are installed, the Pre-wrapped starter boards will adhere in the standard manner.
4. This is the acceptable and tested method for a window head with drainage in Non-combustible construction.

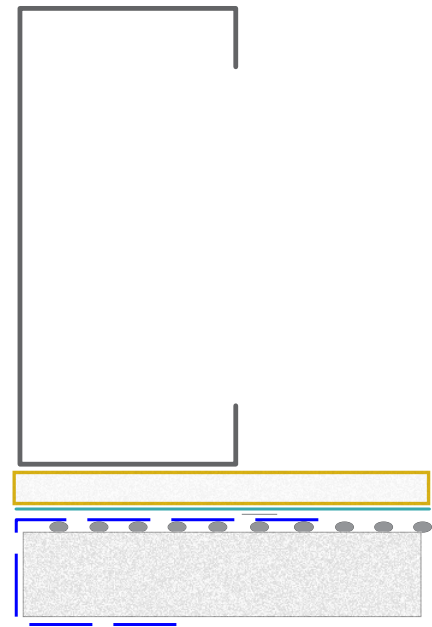

Fig. 1

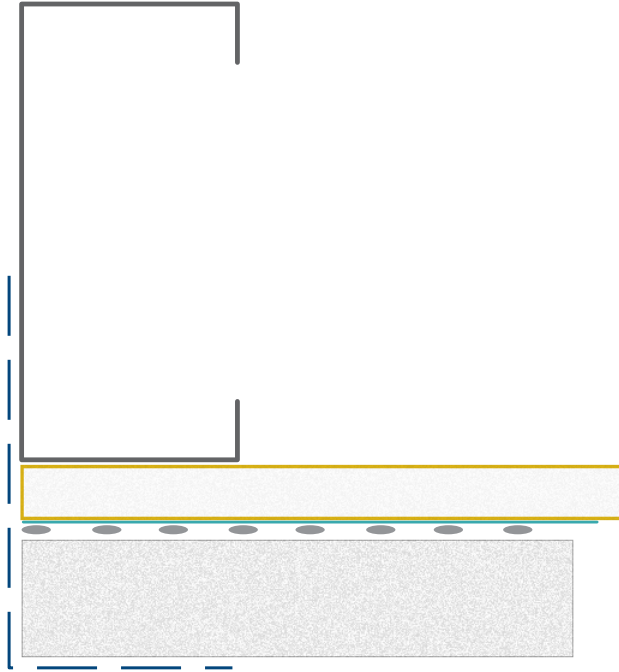

Fig. 2a

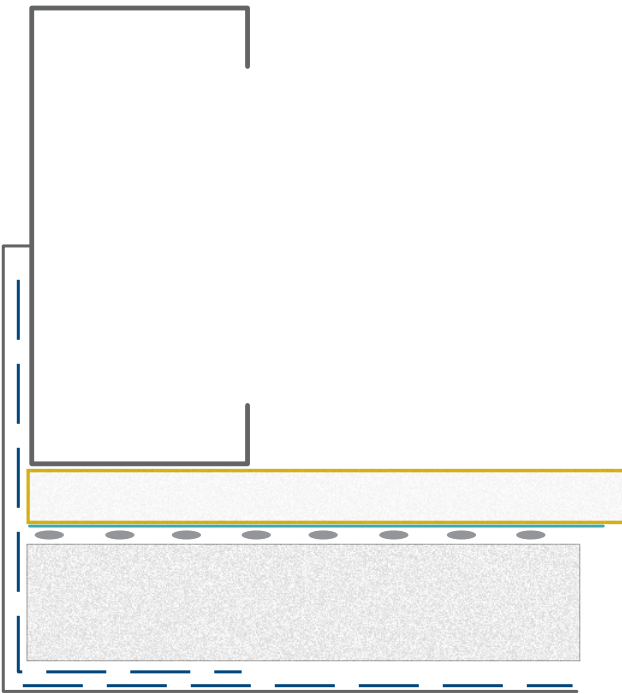

Fig. 2b

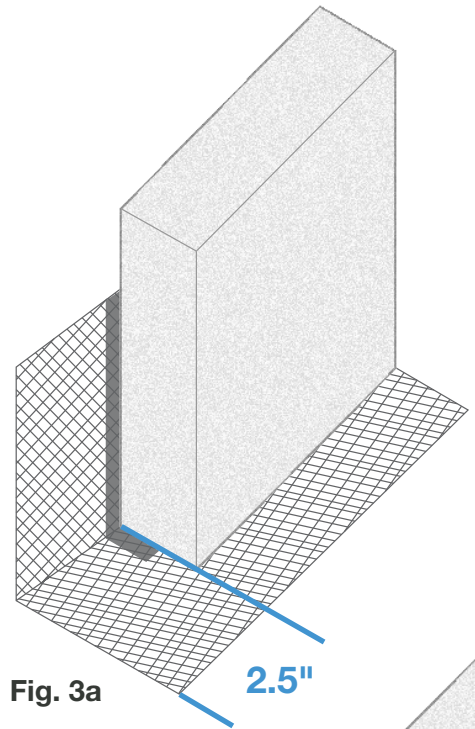

Fig. 3a

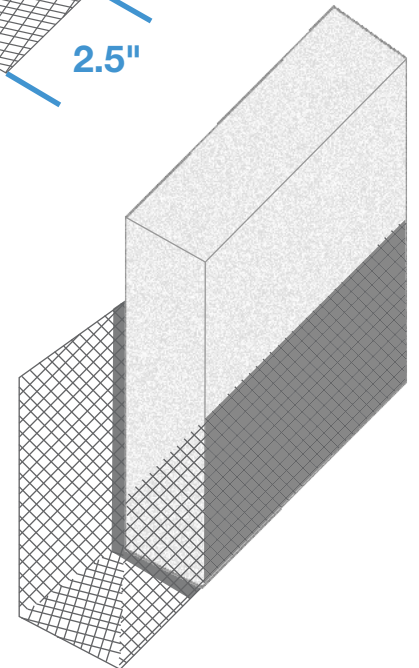

Fig. 3b

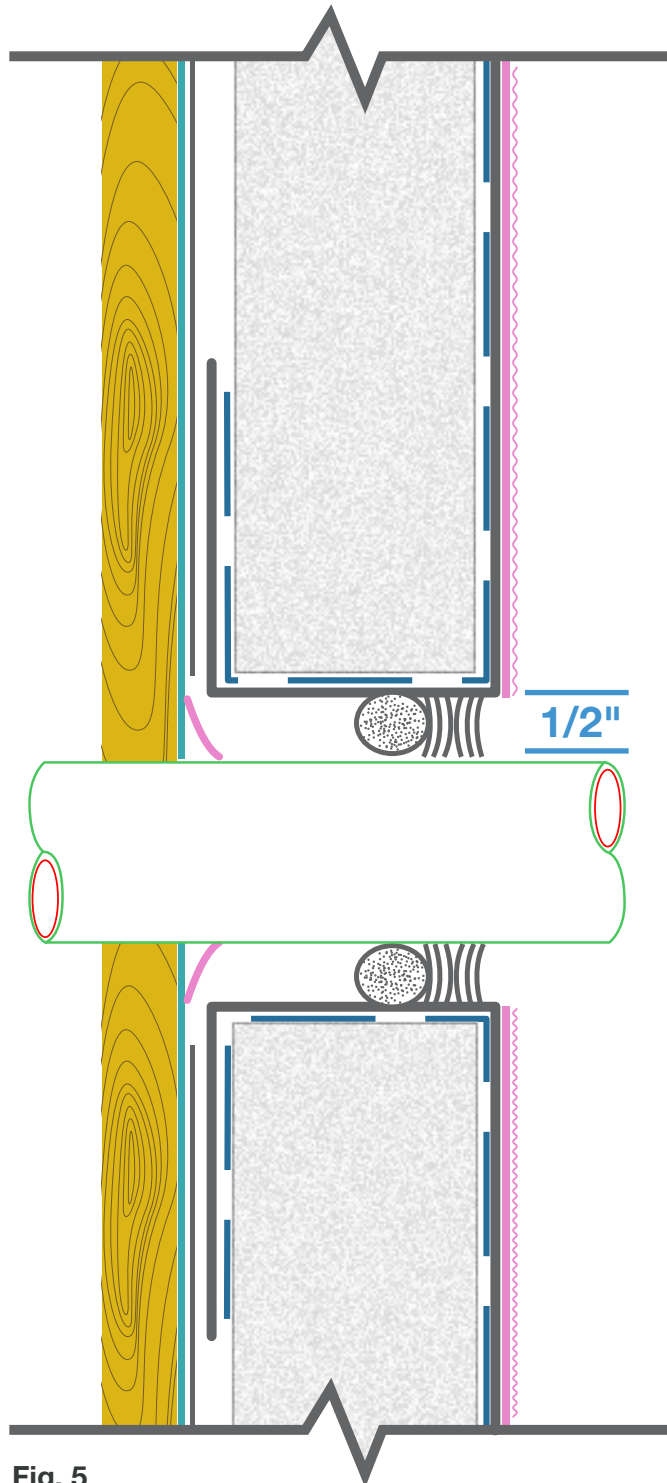

Fig. 5

Starter Track—PVC Track or Drainage Track with weep holes, complying with ASTM D1784 and ASTM C1063. (Fig. 4)

On Non-combustible construction, this product may only be used at the base of walls.

For terminations that require drainage, use tracks with weep holes.

1. Strike a line where the top of the starter track is to be placed.
2. Attach the starter track in line with the mark and attach to the framing at a maximum of 16 inches (406 mm) on the center with the appropriate fastener. Attach between studs as necessary to ensure a flat piece of track is against the wall.
3. Butt sections of track together as tight as possible and miter the corners. The front flanges may need to be cut at corners to allow for the insulation of the insulation boards into the track.

6.3.2 Termination at Penetrations - Fixtures, outlets, hose bibs, vents, etc.

Terminate the EIFS at locations designated on the project details.

1. EIFS must be held back 1/2 inch and back-wrapped to allow for the installation of a sealant joint at these terminations.
2. After Xi-WaterShield and Accessory materials are installed to create a waterproof connection at the penetration, the backwrap will be installed away from the penetration a little more than 1/2 inch. This will allow for a 1/2 inch sealant joint to be installed after the EIF System is in place and dried for 2 days minimum. (Fig. 5)

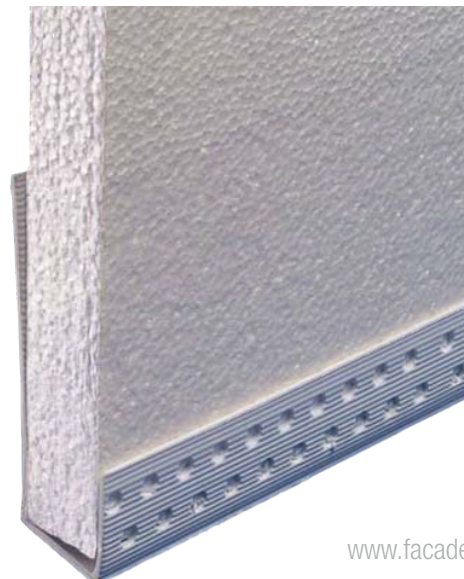

Fig. 4

6.3.3 Expansion joints:

The EIFS must be held back on both sides to create a 3/4" minimum joint.

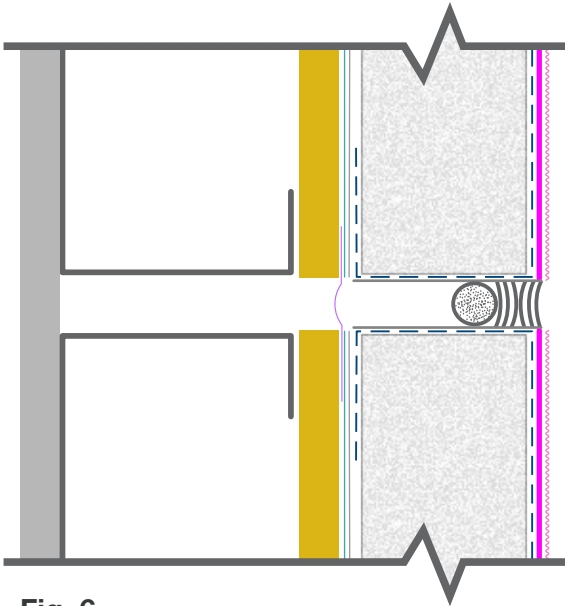

Fig. 6



Fig. 7a

6.4 Drainage

Drainage is required behind all FXI EIFS unless installed over CMU, brick, concrete or a specific variance has been given by FacadesXi, the owner, the designer, and the code official, if applicable.

Xi-Fastened Systems

Drainage Options

- Drainage Mat: Randomly oriented, geometric patterned drainage and ventilation mat or equal. (Fig. 7a)
- Polyolefin sheet good with internal drainage
- Grooved Insulation Board
- Other as approved by FXI

Installation

1. Install drainage mat or other drainage plane material with as few fasteners as possible.
2. The Insulation Board fasteners will permanently hold the drainage mat in place.

WaterShield Xterior Insulation System:

Drainage is achieved with Vertical Ribbons of Adhesive spaced at 1-1/2" apart. (Fig. 7b)

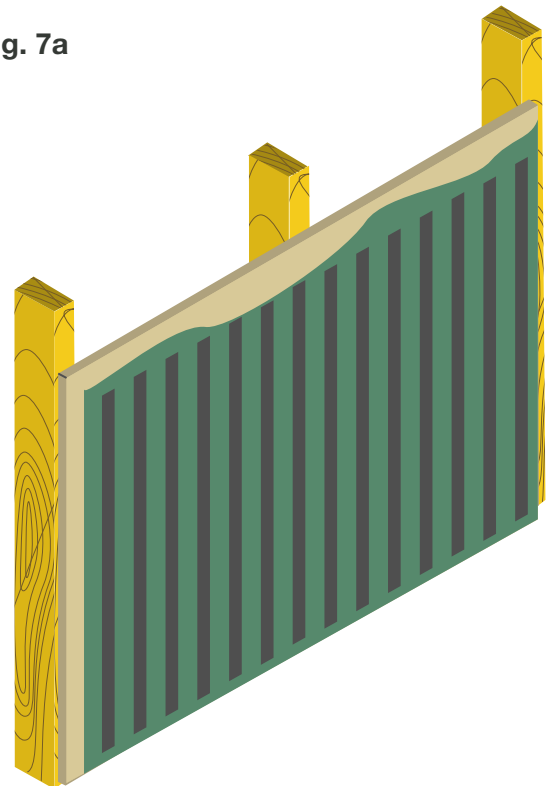

Fig. 7b The adhesive is placed onto the insulation boards and then placed onto the wall. The image is a representation of the ribbons only.

6.5 Xterior Insulation Boards

6.5.1 Board Types

SYSTEM	MIN THICKNESS*	MAX THICKNESS	TYPE
WATERSHIELD XTERIOR Insulation System	3/4"	8"	Expanded Polystyrene (EPS) - Type I
WATERSHIELD XPS XTERIOR Insulation System	3/4"	4"	Extruded Polystyrene (XPS) - PanelCore 20
XTERIOR Insulation System	3/4"	8"	Expanded Polystyrene (EPS) - Type I
Xi-Fastened System	1-1/2"	?	Expanded Polystyrene (EPS) - Type I

*After Rasping

Expanded Polystyrene:

- Nominal 1.0 lb/ft³ (16 kg/m³) in compliance with ASTM C578 Type I /ASTM E2430.
- Size: 2 ft by 4 ft, tolerance per the specifications.
- Boards marked in accordance with the insulation board manufacturer's code compliance Evaluation Report.

Extruded Polystyrene (XPS):

- Styrofoam™ Brand Panel Core 20
- Pre-rasped, Nominal 1.5 lb/ft³ (24 kg/m³) in compliance with ASTM C578 Type X
- All Xterior insulation used on FacadesXi Systems must be produced and labeled following the foam molders' Evaluation Report.
- FacadesXi relies on the molders to produce insulation boards within limits of the specifications. If the boards seem to have poor bead fusion or smell like gas, contact FacadesXi.
- Cutting: EPS and XPS may be cut with a knife, hot knife or table saw. Ensure clean and straight cuts.

6.5.2 Xterior Insulation Attachment

Xi-Fastened System Mechanical Attachment

Xi-Fastened systems are attached through the insulation board and into the studs or sheathing as required. The fastening pattern is based upon the wall structure and the wind load requirements and should be decided by the project engineer before you begin. Design Wind loads for each pattern are listed in the Evaluation Report.

1. Begin at the base of the wall, using temporary support if necessary.
2. Slide insulation boards into the Starter Tracks where backwrap or pre-wrap are not being used.
3. Offset Insulation board joints from sheathing board joints by 12 inches minimum.
4. Insulation boards are installed in running bond.
5. Boards must butt tightly to each other.
6. Follow the fastening pattern given by the project designer.
7. The washer face should be flush with the surface of the insulation board.
8. Continue with installation in Section 6.5.3

***Please view the code report on our website for detailed attachment information.**

WaterShield Xterior Insulation Systems, and Xterior Insulation Systems Adhesive Attachment

1. Begin at the base of the wall, using temporary support if necessary.
2. To minimize horizontal insulation board joints with sheathing board joints, the first row should be 1 foot tall by 4 feet wide boards.
3. Offset vertical Insulation board joints from sheathing board joints by 6 inches minimum to create a running bond.
4. Interlock inside and outside corners of insulation boards. (*Fig 8 - Xi-WaterShield and Adhesive not shown for the clarity of the board placement*)
5. Apply mixed basecoat to the back of the panels with the 1/2" x 1/2" x 1-1/2" spaced notched trowel with the ribbons running vertically. Other notched trowels may be acceptable with approval.
6. Immediately install the boards onto the wall. Do not allow the adhesive to skin over.
7. Apply firm pressure to ensure good adhesion and do not slide the boards into place. The ribbons should be created such that there is space between them after pressing into the Xi-WaterShield coated wall.
8. If drainage is not required, the vertical ribbon spacing may be less than 1-1/2".
9. Boards must butt tightly to each other. If there are gaps, use slivers of EPS (without adhesive) or moisture-cure, low expansion rate, spray-in-place polyurethane foam to fill in the spaces. Do not allow the base coat to flow in between the board joints. If there is base coat between boards, it must be cleaned off.

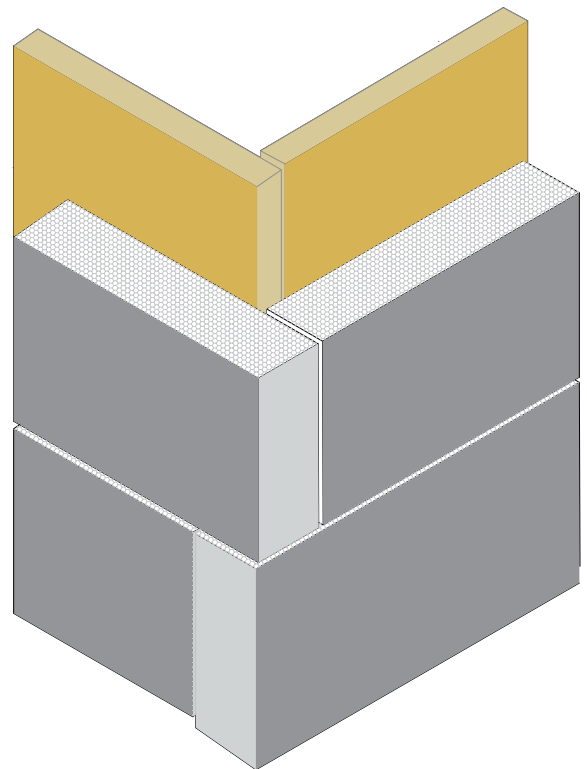

Fig. 8 Xi-WaterShield and Adhesive not shown for the clarity of the board placement.

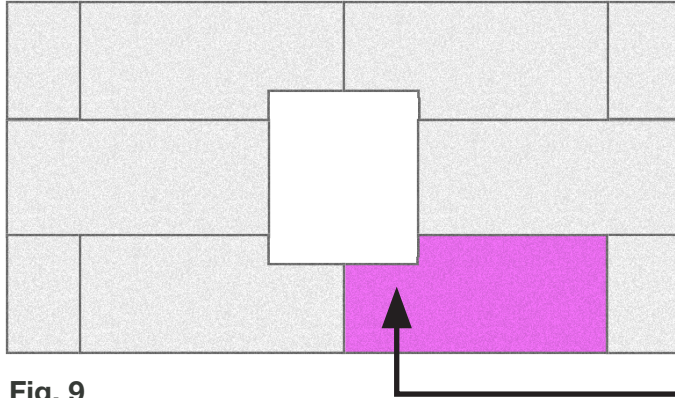

Fig. 9

All boards at corners must be "L" shaped

6.5.3 Rough Openings

Insulation boards should be cut into an L shape around all openings so that board joints do not align with the sheathing board joint. (Fig. 9)

6.5.4 Expansion joints/penetrations

Place insulation boards on either side of the expansion joints and around penetrations to allow for the required sealant joint size (size per project details). (Figure 10)

6.5.5 Rasping/Sanding

1. Once the adhesive has dried overnight (longer in cold weather), the entire insulation board surface should be rasped.
2. Rasping may be done with 20 grit sandpaper min. or an EPS Rasper in a circular motion.
3. Protect the surrounding areas as required from EPS dust/beads by using vacuums or scaffolding netting and clean as required.
4. Clean the surface of any residual dust, EPS pieces, or dirt.

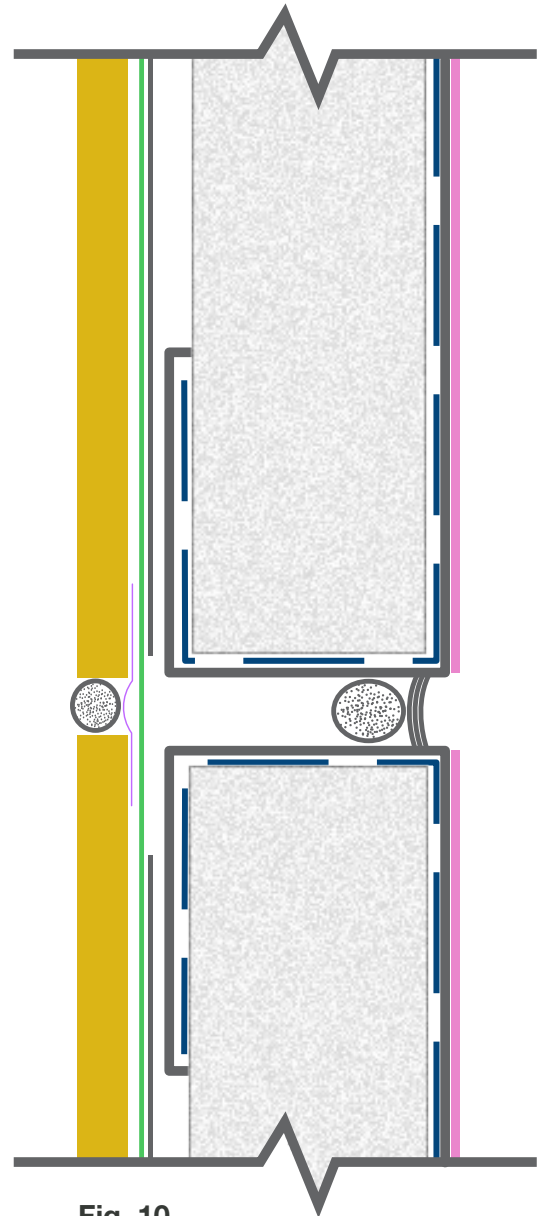

Fig. 10

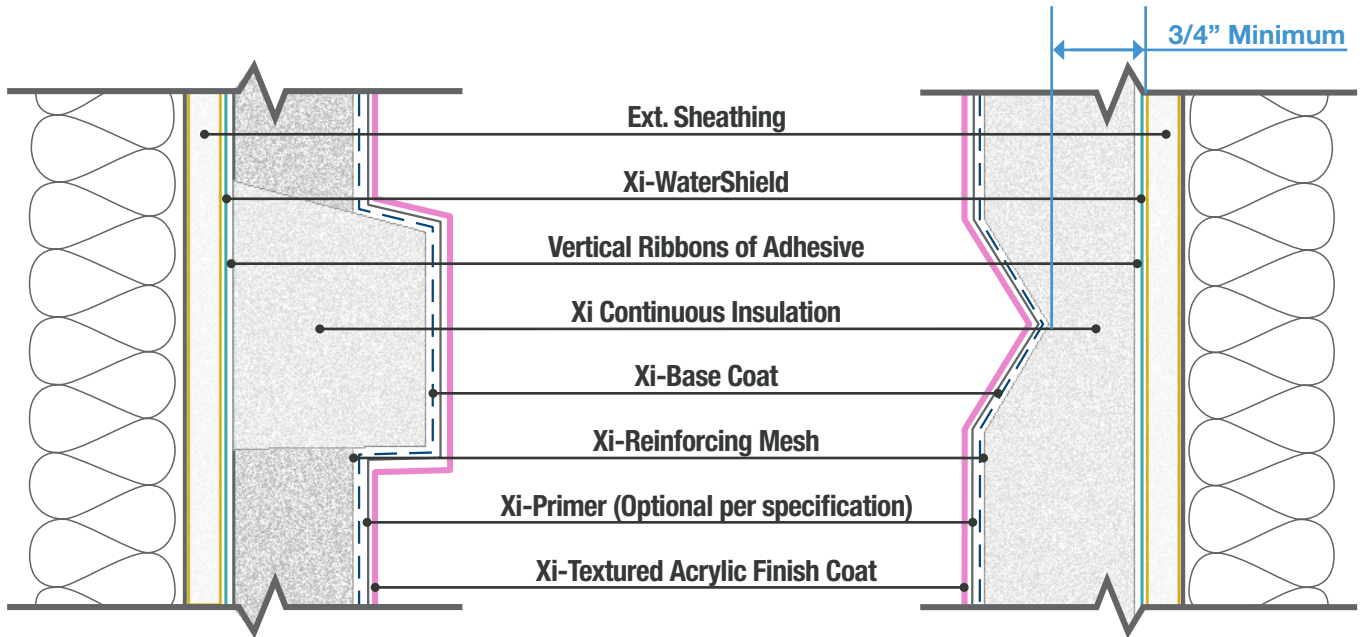

Fig. 11

Fig. 12

6.5.6 Foam Shapes And Reveals

The insulation board reveals and shapes may be cut in the field or before installation

Limitations:

- Slope Minimums
 - » Standing Snow areas – 6:12
 - » No Standing Snow - 3:12
- Sloped surfaces need more maintenance due to the higher probability of dirt gathering, increase heat, and weather exposure.
- Reveals must have a minimum of 3/4 inch of flat insulation at the base of the reveal. See Detail 6.5.6 b
- On non-combustible construction, foam shapes larger than the allowable thickness must be framed out to accommodate the shape.

Installation

Reveals should be marked with a straight edge per the project design and cut with a router or hot knife into the adhered Insulation board.

6.6 Base Coat/Reinforcing Mesh

If the insulation boards have been damaged, overexposed to sunlight, have turned yellow, or if a powder substance has formed, the boards must be rasped and cleaned again.

6.6.1 Backwrap Mesh/Pre-wrap Mesh

Areas that have previously been back-wrapped or pre-wrapped will now have the reinforcing mesh wrapped around the exposed insulation board edge and onto the board face and embedded in wet base coat. The reinforcing mesh must overlap a minimum of 2-1/2 inches.

6.6.2 High or Ultra High impact resistance

High and Ultra High impact areas should be shown on the project documents or listed in the specifications.

1. Uniformly cover the entire foam board surface with the base coat to approximately 1/16" - 1/8" thick.
2. With the flat edge of a stainless-steel trowel, embed the Xi-BearMat into the base coat, from the center to the edges, wrapping it around the edges and system terminations.
3. Do not Lap BearMats. They must be butted tightly.
4. Xi-BearMat must be covered with a layer of Xi-Mesh.

6.6.3 Reinforcing Mesh in Reveals

- There must be continuous reinforcing mesh through the reveal and a minimum of 2.5 inches beyond the reveal.
- Use a reveal trowel or tool to help embed the mesh into the cutout.
- Ensure not to cut the reinforcing mesh. If the mesh is cut, a new mesh must be installed.

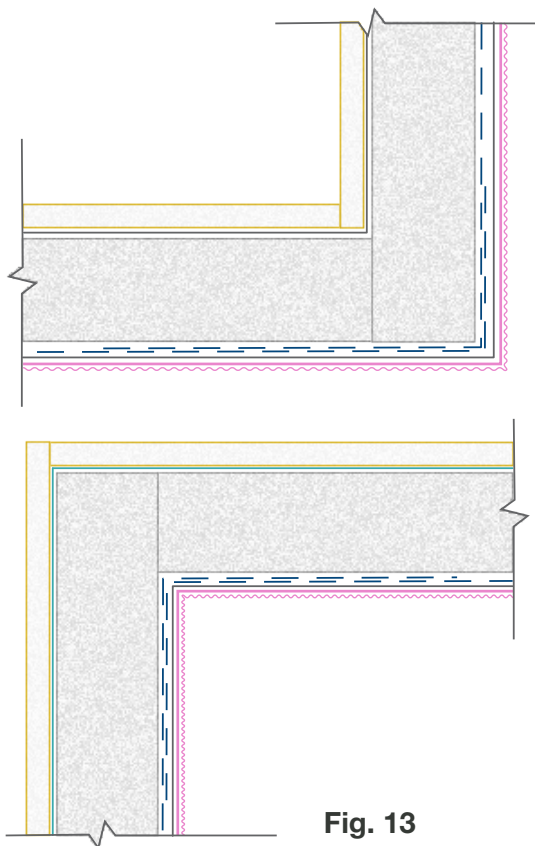

Fig. 13

6.6.4 Foam Shapes

Horizontal/Sloped Foam Shapes with surfaces greater than 2 inches must be coated with Xi – WaterLock.

6.6.5 Outside Corners

- Reinforcing mesh must run continuously around corners and the mesh should not be overlapped within 8 inches of the corner.
- It is recommended that corners should be protected with a double layer of reinforcing mesh. See Project Specifications.
- See Fig. 13.

6.6.6 Rough Openings

At large openings where the reinforcing mesh may have left gaps of coverage in the corners, butterfly pieces should be placed in the corner as shown below. (Fig. 14)

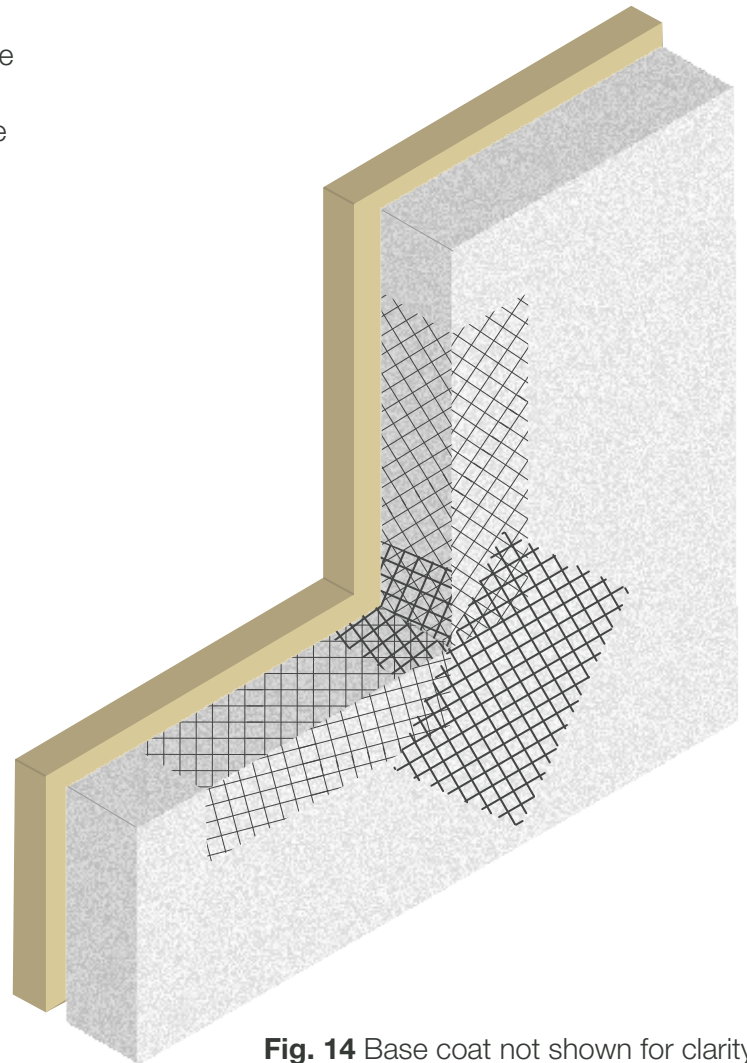

Fig. 14 Base coat not shown for clarity.

6.6.7 Lamina Application

1. Uniformly cover the entire insulation board surface with the base coat to approximately 1/16" - 1/8" thick. With the flat edge of a stainless-steel trowel, embed reinforcing mesh into the base coat. Start from the center and work to the edges, wrapping it around the edges and system terminations.
2. Use the mesh to gauge base coat thickness. The mesh-reinforced surface should be flat and smooth with no wrinkles. A damp, NOT WET, brush may be used on fresh or uncured base coat to maintain sharp edges of grooves or for smoothing trowel marks.
3. The mesh color is not visible at a minimum of 1/16". If the mesh color is visible, a second layer of base coat can be applied.
4. Lap reinforcing mesh 2-1/2" minimum at edges.
5. Allow to dry (normally 8 hours).



6.7 Sealant Joints

- Protect the areas to receive sealant while installing Xi-Textured Acrylic Finish to keep the areas clean.
- The installation of sealant joints must be per the sealant manufacturer's installation instructions and located and sized per the project design.
- Sealant is to be installed between the dissimilar material and the EIFS Reinforced Basecoat.
- Do not install sealant onto the finish coat without approval from FacadesXi.
- If the base coat is not smooth, smooth the surface out with a skim coat of Xi-Base coat material.
- Tinted primer may be installed into the joint where the sealant is to be installed.



6.8 Primer

Primer is optional per the project designer but always recommended for the smoothest most consistent color and texture. Check the specifications for requirements.

1. Ensure the base coat is clean and dry.
2. Primer can be roller, brush, or spray applied to the entire area to receive a finish coat.
3. Apply to the entire surface with a brush, 3/8" nap roller, or spray equipment at a coverage rate of 1500 ft² per pail. Work product into all corners and joints.
4. Protect from rain, and freezing, until dry (at least 1-4 hours, longer in cold or humid climates) before application of finishes.

6.9 Finish Coat

Double-check the color is the selected color. Color and samples must be approved by the owner before installation.

1. Always maintain a wet edge when applying.
2. Work product into all corners and joints for smooth application.
3. Cover each wall section with a finish from the same batch number to maintain color consistency. Batch to batch may have very slight color variations.
4. Do not apply in direct sunlight.
5. Apply the product with a clean, stainless steel trowel.
6. Maintain a uniform thickness based on the largest aggregate size of the finish when applying the finish coat.
7. Do not install onto areas to receive sealant joints.
8. Under normal humidity and temperatures, drying time ranges from 1- 4 hours. Drying time may exceed this range with high humidity and cold temperature
9. Protect the finish coat from rain and/or freezing until cured (at least 1- 4 hours, longer in cold or humid climates)

Standard Finishes except Smooth:

1. Product can be applied with a plastic float or stainless steel trowel; however, stainless steel is recommended for the large, aggregated finish.
2. Continuously clean tools throughout the texturing process.

3. Always maintain consistent pressure and movement throughout the application to achieve the best texturing results.
4. Float the finish before it has set up (approx. 20 minutes depending on temperature and humidity) to avoid pulling aggregate and creating a non-uniform surface.

Xi-Smooth & Xi-Smooth Extra:

1. Two tight coats are typically required to achieve the smoothest appearance.
2. Use a clean, stainless steel trowel and apply the first coat. Allow it to dry thoroughly.
3. Apply the second coat and trowel to the desired smoothness when the second coat is partially dry.
4. To further enhance smoothness, add light, consistent water mist during the smoothing process.

Note: Variations in smoothness and color appearance should be expected.

Xi-Smooth Limestone:

1. Follow Xi-Smooth Steps 1-4 above
2. Coat 1: Xi-Fine 1.0
3. Coat 2: Xi-Smooth

Spray application recommendations:

For best results, maintain a consistent distance, motion pressure, and angle for the entire project.

Note: A sample/mock-up should be submitted and approved using the same tools, methods, and products that will be used on the project.

Thank you for the use of FacadesXi Materials and Systems. We are here to help. Please call or email us if you have any questions or need any assistance.

technical@facadesxi.com | info@facadesxi.com





**15262 Capital Port
San Antonio, TX 78249**

phone 210-538-8742
toll-free 1-833-899-0787
e-mail info@facadesxi.com

www.facadesxi.com

© 2022 Facades Xi